

DS-2TD2617-10/PA Thermal & Optical Bi-spectrum Network Bullet Camera

DeepinView^{series}



Hikvision DS-2TD2617-10/PA Thermal & Optical Bi-spectrum Network Bullet Camera, equipped with built-in GPU which supports intelligent behavior analysis algorithm, can realize high-precision VCA detection and real-time alarm. It is applied to perimeter protection and fire prevention purposes in commercial facilities such as residential, retail, villa, parking lot, museum, data centers and so on. The pre-alarm system helps you discover unexpected events immediately and protects your property.

Key Feature

- Behavior analysis function, based on deep learning algorithm: line crossing, intrusion, region entrance & exit
- Temperature exception alarm
- Fire detection algorithm
- 160 × 120 (the resolution of output image is 320 × 240) resolution 17 μm, VOx UFPA, NETD ≤ 40 mK (25 °C, F# = 1.1)
- Image processing technology: Liner, histogram, and self-adaptive thermal AGC mode, DDE, 3D DNR



Specification

Thermal Module	
Image Sensor	Vanadium Oxide Uncooled Focal Plane Arrays
Resolution	160 × 120 (the resolution of output image is 320 × 240)
Pixel Interval	17 μm
Response Waveband	8 μm to 14 μm
NETD (Noise Equivalent Temperature Difference)	≤ 40 mk (25 °C, F# = 1.1)
Focal Length	9.7 mm
IFOV	2.74 mrad
Field of View	15.96° × 12° (H × V)
Min. Focusing Distance	1.2 m
Aperture	F 1.1
Digital Zoom	×2, ×4, ×8
Optical Module	
Image Sensor	1/2.7" Progressive Scan CMOS
Resolution	2688 × 1520
Min. Illumination	Color: 0.0089 Lux @(F1.6, AGC ON), B/W: 0.0018 Lux @(F1.6, AGC ON)
Shutter Speed	1 s to 1/100,000 s
Focal Length	8 mm
Field of View	39.42° × 22.14° (H × V)
Aperture	F1.7
WDR	120 dB
Image Effect	
Picture in Picture	Display partial image of thermal channel on the full screen of optical channel
Bi-spectrum Image Fusion	Display the details of optical channel on thermal channel
Target Coloration	Yes. Supported in white hot and black hot mode.
Smart Function	
VCA (Video Content Analysis)	4 VCA rule types (line crossing, intrusion, region entrance, and region exiting), up to 8 VCA rules in total.
Temperature Measurement	3 temperature measurement rule types, 21 rules in total (10 points, 10 areas, and 1 line).
Temperature Range	-20 °C to + 150 °C (-4 °F to + 302°F)
Temperature Accuracy	± 8 °C (± 14.4 °F)
Fire Detection	Dynamic fire detection, up to 10 fire points detectable.
Illuminator	
IR Distance	Up to 40 m
IR Intensity and Angle	Automatically adjusted

Audible and Visual Alarm	
White Light Range	Up to 40 m
Visual Alarm	Yes. White light used as the visual alarm, flashing frequency adjustable
Audio alarm	Yes. 6 audio alarms are supported to cover all kinds of alarm.
Video & Audio	
Main Stream	Optical channel 50 Hz: 25 fps (2688 × 1520, 1920 × 1080, 1280 × 720) 60 Hz: 30 fps (2688 × 1520, 1920 × 1080, 1280 × 720) Thermal channel 25fps (1280 × 720, 704 × 576, 640 × 480, 352 × 288, 320 × 240)
Sub-stream	Optical channel 50 Hz: 25 fps (704 × 576, 352 × 288, 176 × 144) 60 Hz: 30 fps (704 × 480, 352 × 240, 176 × 120) Thermal channel 25fps (704 × 576, 352 × 288, 320 × 240)
Video Compression	Main Stream: H.265/H.264 Sub-Stream: H.265/H.264/MJPEG
Audio Compression	G.711u/G.711a/G.722.1/MP2L2/G.726/PCM
Network	
Protocols	IPv4/IPv6, HTTP, HTTPS, 802.1x, Qos, FTP, SMTP, UPnP, SNMP, DNS, DDNS, NTP, RTSP, RTCP, RTP, TCP, UDP, IGMP, ICMP, DHCP, PPPoE
Network Storage	MicroSD/SDHC/SDXC card (up to 256 G) local storage, and NAS (NFS, SMB/CIFS), auto network replenishment (ANR)
API	ISAPI, HIKVISION SDK, third-party management platform, ONVIF (Profile S, Profile G, Profile T)
Simultaneous Live View	Up to 20 channels
User/Host Level	Up to 32 users, 3 levels: Administrator, Operator, User
Security	User authentication (ID and PW), MAC address binding, HTTPS encryption, IEEE 802.1x(EAP-MD5, EAP-TLS), access control, IP address filtering
Client	iVMS-4200, Hik-Connect
Web Browser	Live view (plug-in allowed) : Internet Explorer 11 Live view (plug-in free) : Chrome 57.0 +, Firefox 52.0 + Local service : Chrome 57.0+, Firefox 52.0 +
Interface	
Alarm Input	2-ch inputs (0-5 VDC)
Alarm Output	2-ch relay outputs, alarm response actions configurable
Alarm Action	SD recording/relay output/smart capture/FTP upload/email linkage/audio alarm/white light alarm
Audio Input	1, 3.5 mm Mic in/Line in interface Line input: 2 to 2.4 V [p-p], output impedance: 1 K Ω \pm 10%
Audio Output	Linear level, impedance: 600 Ω
Communication Interface	1, RJ45 10 M/100 M self-adaptive Ethernet interface 1, RS-485 interface

General

Menu language	32 languages English, Russian, Estonian, Bulgarian, Hungarian, Greek, German, Italian, Czech, Slovak, French, Polish, Dutch, Portuguese, Spanish, Romanian, Danish, Swedish, Norwegian, Finnish, Croatian, Slovenian, Serbian, Turkish, Korean, Traditional Chinese, Thai, Vietnamese, Japanese, Latvian, Lithuanian, Portuguese (Brazil)
Power	12 VDC \pm 20%, two-core terminal block PoE (802.3af, class 3)
Power Consumption	12 VDC \pm 20%: 0.65 A, max. 7.5 W PoE (802.3af, class 3): 42.5 V to 57 V, 0.14 A to 0.22 A, max. 8 W
Working Temperature/Humidity	Temperature: -40 °C to 65 °C (-40 °F to 149 °F) Humidity: 95% or less
Protection Level	IP66 Standard TVS 6000V lightning protection, surge protection, voltage transient protection
Dimensions	358.3 mm \times 113.5 mm \times 115.2 mm (14.10" \times 4.47" \times 4.53")
Weight	Approx. 1.76 kg (3.88 lb)

DRI Range Table

* The table is only for reference and the performance may vary according to different environment.

* The optimal human detection, recognition, and identification distances are calculated according to Johnson's Criteria.

Detection Range: In order to distinguish an object from the background, the object must be covered by 1.5 or more pixels.

Recognition Range: In order to classify the object (animal, human, vehicle, etc.), the object must be covered by 6 or more pixels.

Identification Range: In order to identify the object and describe it in details, the object must be covered by 12 or more pixels.

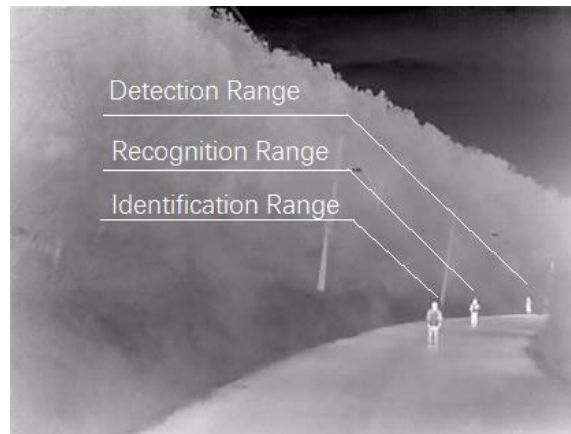

Detection Range (Vehicles: 1.4 × 4.0 m)	Detection Range (Humans: 1.8 × 0.5 m)	Recognition Range (Vehicles: 1.4 × 4.0 m)	Recognition Range (Humans: 1.8 × 0.5 m)	Identification Range (Vehicles: 1.4 × 4.0 m)	Identification Range (Humans: 1.8 × 0.5 m)
875 m	285 m	219 m	71 m	109 m	36 m

Smart Function Table

* The table is only for reference and the performance may vary according to different environment.

VCA Range (Vehicles: 1.4 × 4.0 m)	VCA Range (Humans: 1.8 × 0.5 m)	Temperature Measurement (Object: 2 × 2 m)	Temperature Measurement (Object: 1 × 1 m)	Fire Detection (Object: 2 × 2 m)	Fire Detection (Object: 1 × 1 m)
150 m	50 m	235 m	118 m	588 m	294 m

Available Model

DS-2TD2617-10/PA

Dimension

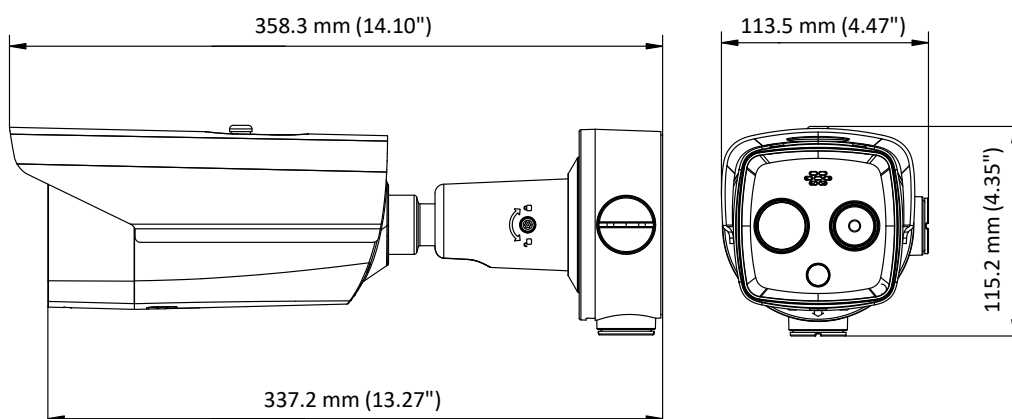

▪ Accessory

DS-1275ZJ-S-SUS
Vertical Pole Mount



DS-1276ZJ-S-SUS
Corner Mount

COMPLIANCE NOTICE: The thermal series products might be subject to export controls in various countries or regions, including without limitation, the United States, European Union, United Kingdom and/or other member countries of the Wassenaar Arrangement. Please consult your professional legal or compliance expert or local government authorities for any necessary export license requirements if you intend to transfer, export, re-export the thermal series products between different countries.

Distributed by

**HIKVISION®****Headquarters**

No.555 Qianmo Road, Binjiang District,
Hangzhou 310051, China
T +86-571-8807-5998
overseasbusiness@hikvision.com

Hikvision USA
T +1-909-895-0400
sales.usa@hikvision.com

Hikvision Australia
T +61-2-8599-4233
salesau@hikvision.com

Hikvision India
T +91-22-28469900
sales@pramahikvision.com

Hikvision Canada
T +1-866-200-6690
sales.canada@hikvision.com

Hikvision Thailand
T +662-275-9949
sales.thailand@hikvision.com

Hikvision Europe
T +31-23-5542770
sales.eu@hikvision.com

Hikvision Italy
T +39-0438-6902
info.it@hikvision.com

Hikvision Brazil
T +55 11 3318-0050
Latam.support@hikvision.com

Hikvision Turkey
T +90 (216)521 7070- 7074
sales.tr@hikvision.com

Hikvision Malaysia
T +601-7652-2413
sales.my@hikvision.com

Hikvision UK & Ireland
T +01628-902140
sales.uk@hikvision.com

Hikvision South Africa
Tel: +27 (10) 0351172
sale.africa@hikvision.com

Hikvision France
T +33(0)1-85-330-450
info.fr@hikvision.com

Hikvision Kazakhstan
T +7-727-9730667
nikia.panfilov@hikvision.ru

Hikvision Vietnam
T +84-974270888
sales.vt@hikvision.com

Hikvision UAE
T +971-4-4432090
salesme@hikvision.com

Hikvision Singapore
T +65-6684-4718
sg@hikvision.com

Hikvision Spain
T +34-91-737-16-55
info.es@hikvision.com

Hikvision Tashkent
T +99-87-1238-9438
uzb@hikvision.ru

Hikvision Hong Kong
T +852-2151-1761
info.hk@hikvision.com

Hikvision Russia
T +7-495-669-67-99
saleru@hikvision.com

Hikvision Korea
T +82-(0)31-731-8817
sales.korea@hikvision.com

Hikvision Poland
T +48-22-460-01-50
info.pl@hikvision.com

Hikvision Indonesia
T +62-21-2933759
Sales.Indonesia@hikvision.com

Hikvision Colombia
sales.colombia@hikvision.com